

**Mechanical Dimensions: Inches [mm]**

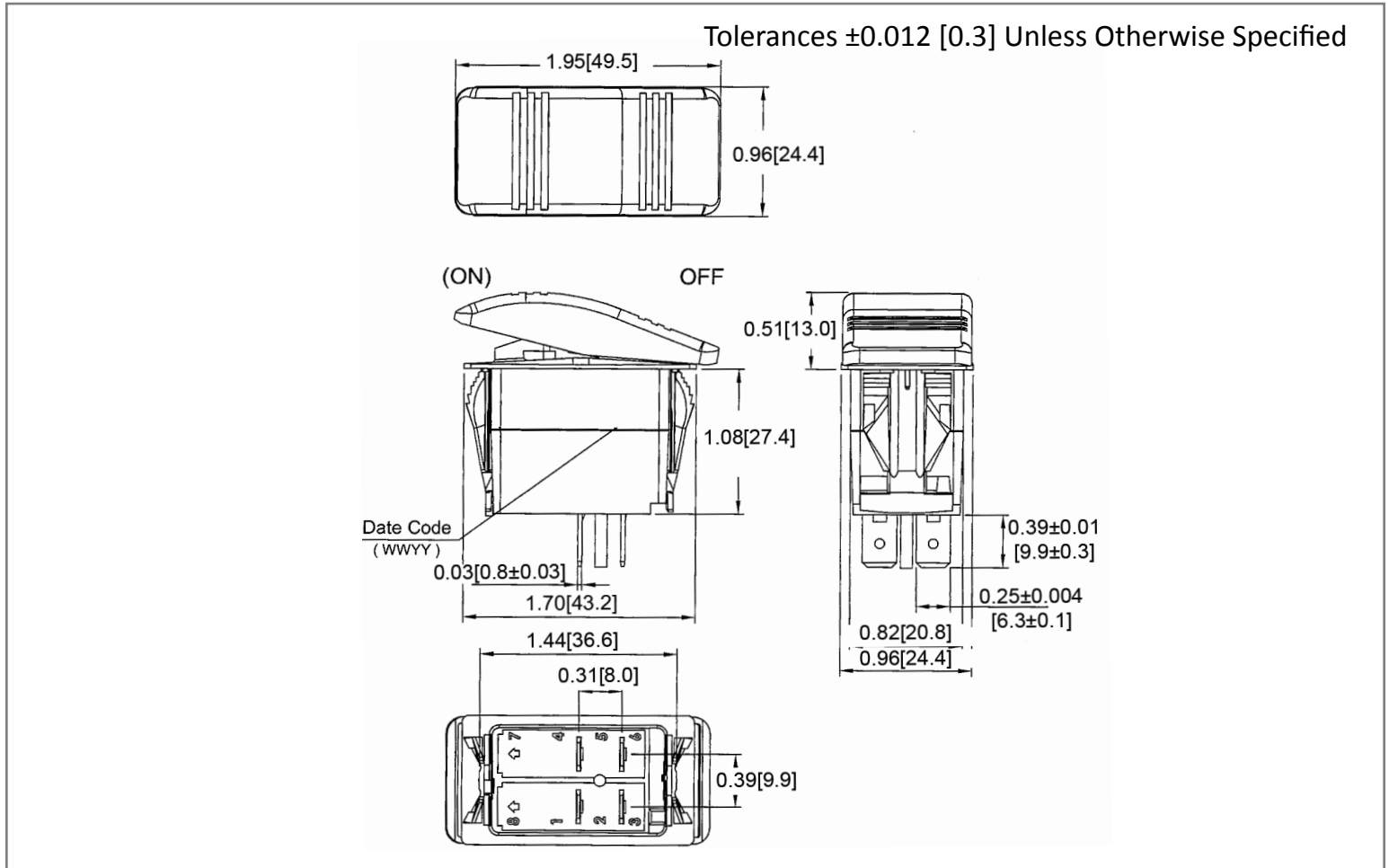

**Mounting Hole**

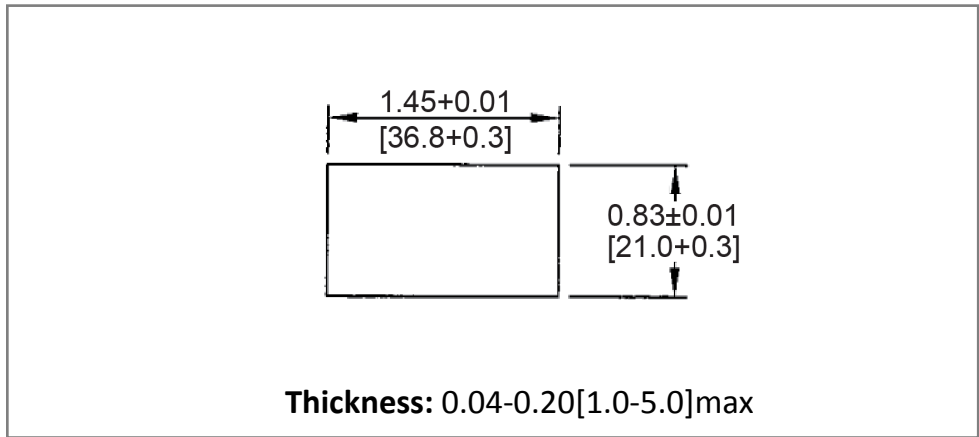

**Circuit Diagram**

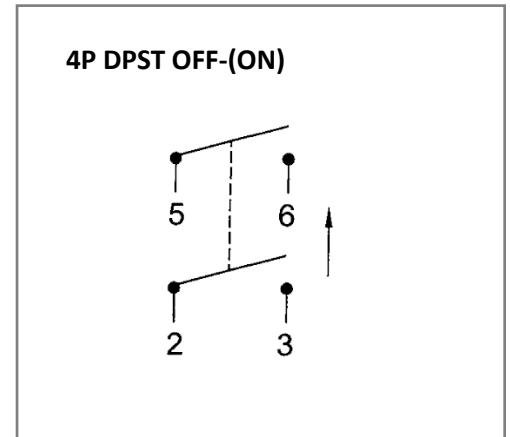

**Electrical Specifications**

<b>Rating</b>	21A 14V DC
<b>Contact Resistance</b>	50m ohm Max
<b>Insulation Resistance</b>	DC 500V 100M ohm Min
<b>Dielectric Strength</b>	AC 1500V 1 minute
<b>Operation Temperature</b>	-25°C~85°C

**Material Specifications**

<b>Frame</b>	Black, Nylon 66 (94V-2)
<b>Actuator</b>	Red, Nylon 66 (94V-2)
<b>Terminals</b>	Silver plated copper
<b>Splash-proof</b>	IP56

Rev	Date of issue	Revision Notes	Designed	Approved
B	06-25-2021	Initial Drawing	RC	OF