

UV SMD LED With Silicone Lens

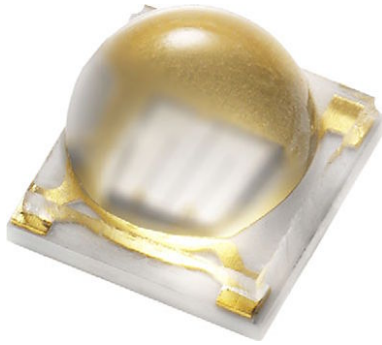

DESCRIPTION

VLMU3511-365-130 is a ceramic based high power UV LED with silicone lens for long life time. The package size is 3.45 mm x 3.45 mm and the radiant power up to 1325 mW at 600 mA in a wavelength range of 360 nm to 370 nm.

PRODUCT GROUP AND PACKAGE DATA

- Product group: LED
- Package: SMD ceramic high power
- Product series: high power UV LED
- Angle of half intensity: $\pm 65^\circ$
- Lead-finishing: Au

SAFETY ADVICES

Depending on the mode of operation, these devices emit highly concentrated non visible ultraviolet light which can be hazardous to the human eye. Products which incorporate these devices have to follow the safety precautions given in IEC 62471 "Photobiological Safety of Lamps and Lamp Systems".

FEATURES

- Ceramic SMT package with silicone lens
- Dimension (L x W x H) in mm: 3.45 x 3.45 x 2.1
- Forward current: up to 700 mA
- Radiant power (typ.): 1000 mW at 600 mA
- Materials:
 - Die: InGaN
 - Resin: silicone (water clear)
 - Leads / terminations finish: gold plated (Au)
- Grouping parameters:
 - Forward voltage
 - Radiant power
 - Peak wavelength
- Reflow soldering method
- MSL 3 according to J-STD-020
- Packaging: MOQ = 1000 pieces; 12 mm tape with 500 pieces per reel, \varnothing 180 mm (7")
- Material categorization: for definitions of compliance please see www.vishay.com/doc?99912



APPLICATIONS

- Industrial curing
- Photocatalytic purification
- Poster printing curing
- Counterfeit money detector
- Blood detector
- Nail curing
- Teeth curing

PARTS TABLE

PART	COLOR	RADIANT POWER (mW)			at I _F (mA)	WAVELENGTH (nm)			at I _F (mA)	FORWARD VOLTAGE (V)			at I _F (mA)	TECHNOLOGY
		MIN.	TYP.	MAX.		MIN.	TYP.	MAX.		MIN.	TYP.	MAX.		
VLMU3511-365-130	Ultraviolet	835	1000	1325	600	360	367	370	600	3.2	3.6	4.0	600	InGaN

ABSOLUTE MAXIMUM RATINGS (T_{amb} = 25 °C, unless otherwise specified) VLMU3511-365-130

PARAMETER	TEST CONDITION	SYMBOL	VALUE	UNIT
DC forward current		I _F	700	mA
Power dissipation		P _V	2.8	W
Electrostatic discharge	HBM: MIL-STD-883 C 3B	ESD	2000	V
Junction temperature		T _j	+95	°C
Operating temperature range		T _{amb}	-40 to +85	°C
Storage temperature range		T _{stg}	-55 to +95	°C
Solder temperature		T _{sol}	260	°C



OPTICAL AND ELECTRICAL CHARACTERISTICS ($T_{amb} = 25\text{ }^{\circ}\text{C}$, unless otherwise specified) VLMU3511-365-130, ULTRAVIOLET						
PARAMETER	TEST CONDITION	SYMBOL	MIN.	TYP.	MAX.	UNIT
Forward voltage	$I_F = 600\text{ mA}$	V_F	3.2	3.6	4.0	V
Radiant power	$I_F = 600\text{ mA}$		835	1000	1325	mW
Radiant intensity	$I_F = 600\text{ mA}$		-	330	-	mW/sr
Peak wavelength	$I_F = 600\text{ mA}$	λ_p	360	367	370	nm
Angle of half intensity	$I_F = 600\text{ mA}$	ϕ	-	± 65	-	$^{\circ}$
Thermal resistance junction to case		R_{thJC}	-	5.1	-	K/W

Note

- Tolerances: $\pm 11\%$ for ϕ_e , $\pm 0.1\text{ V}$ for V_F , $\pm 3\text{ nm}$ for λ_p .

RADIANT POWER CLASSIFICATION ($I_F = 600\text{ mA}$)			
GROUP	MIN.	MAX.	UNIT
MN	835	900	mW
NO	900	975	
OP	975	1050	
PR	1050	1135	
RS	1135	1225	
ST	1225	1325	

PEAK WAVELENGTH CLASSIFICATION ($I_F = 600\text{ mA}$)			
GROUP	MIN.	MAX.	UNIT
P3M	360	365	nm
P3N	365	370	

FORWARD VOLTAGE CLASSIFICATION ($I_F = 600\text{ mA}$)			
GROUP	MIN.	MAX.	UNIT
V1	3.2	3.6	V
V2	3.6	4.0	

Note

- In order to ensure availability, single groups for radiant intensity, wavelength, and forward voltage will not be orderable. Only one group for radiant intensity, wavelength, and forward voltage will be shipped in any one reel

MARKING EXAMPLE FOR SELECTION CODE ON LABEL

Selection code: OP-P3N-V2

- OP range: 975 mW to 1050 mW
- P3N range: 365 nm to 370 nm
- V2 range: 3.6 V to 4.0 V

TYPICAL CHARACTERISTICS ($T_{amb} = 25\text{ }^{\circ}\text{C}$, unless otherwise specified)

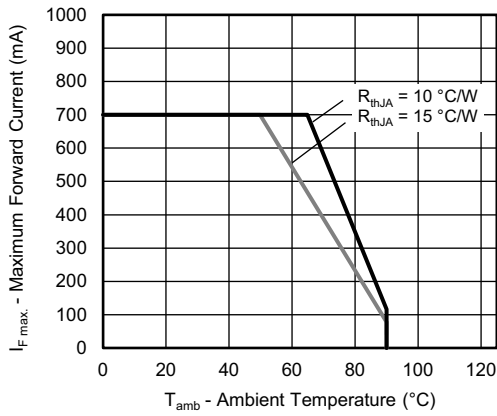

Fig. 1 - Maximum Forward Current vs. Ambient Temperature

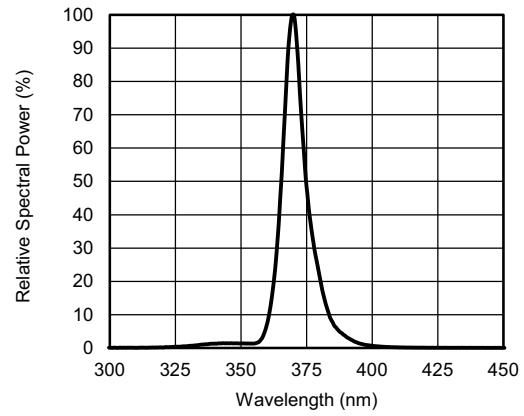

Fig. 4 - Relative Spectral Power vs. Wavelength

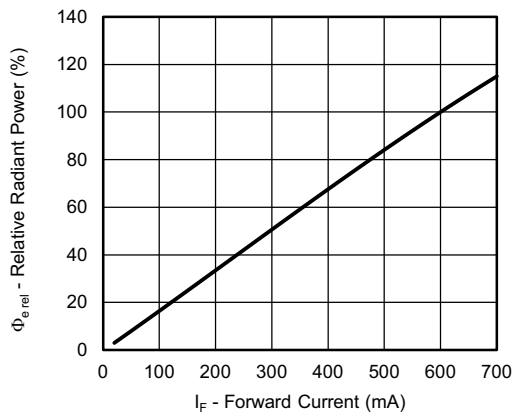

Fig. 2 - Relative Radiant Power vs. Forward Current

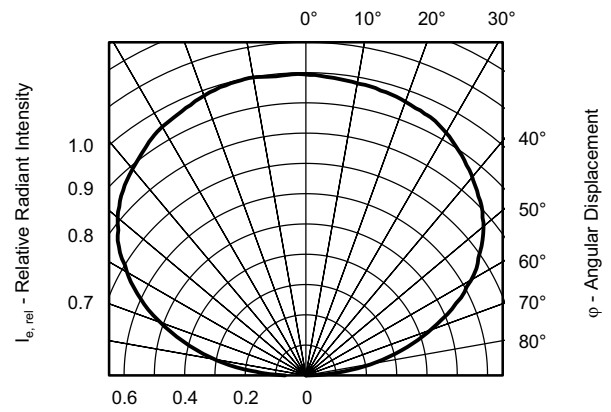

Fig. 5 - Relative Radiant Intensity vs. Angular Displacement

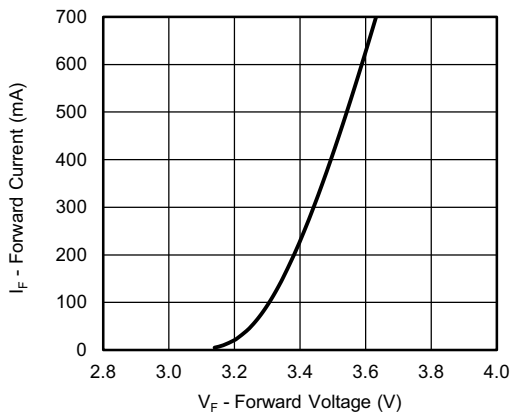

Fig. 3 - Forward Current vs. Forward Voltage

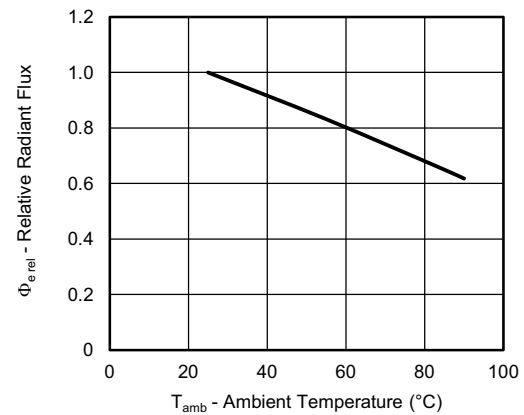
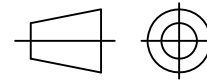
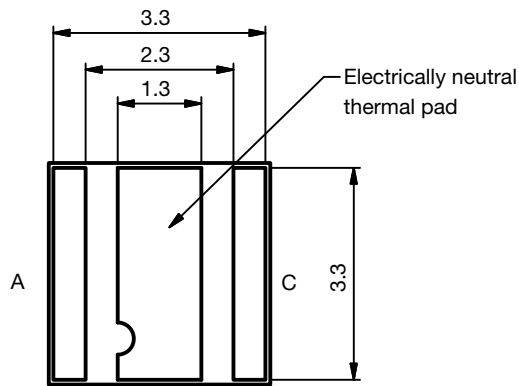
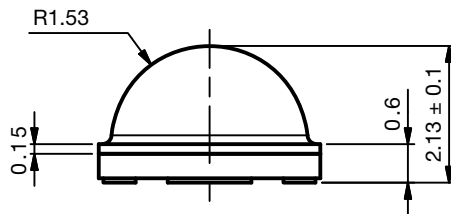

Fig. 6 - Relative Radiant Flux vs. Ambient Temperature

PACKAGE DIMENSIONS in millimeters



Technical drawings according to DIN specification.



Not indicated tolerances ± 0.2

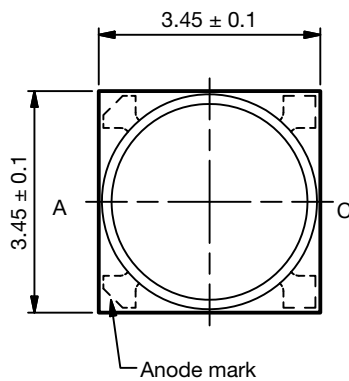

Recommended solder pad footprint

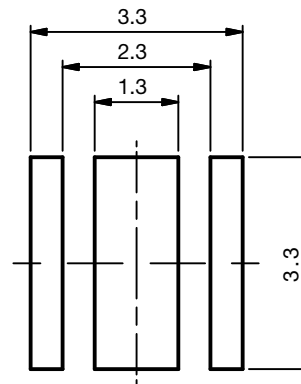

Drawing-No.: 6.541-5112.01-4
Issue: prel; 27.01.16

WIRING

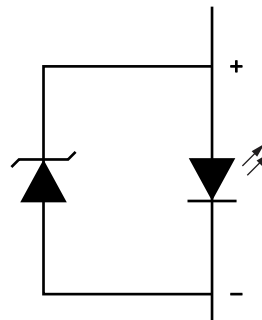
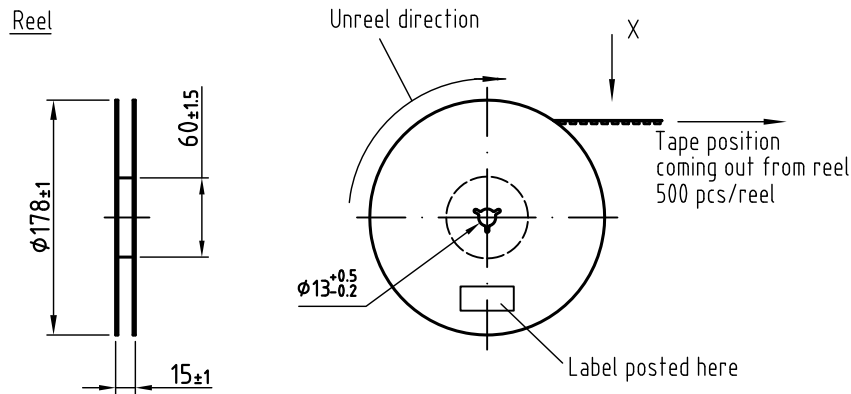
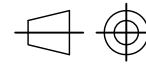

Fig. 7 - Wiring Diagram

TAPE AND REEL DIMENSIONS in millimeters



All dimensions in mm



technical drawings according to DIN specifications

Leader and trailer tape:

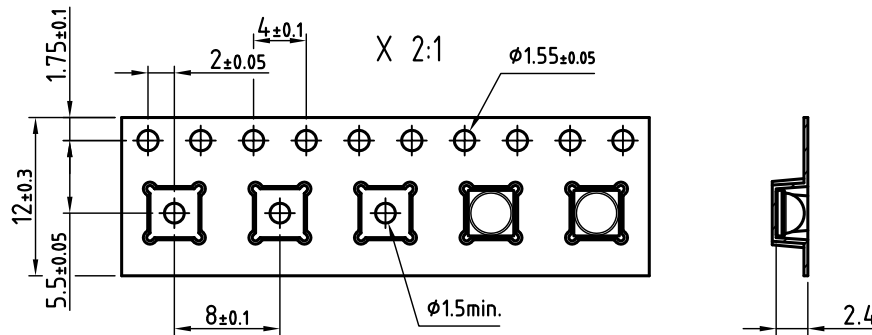
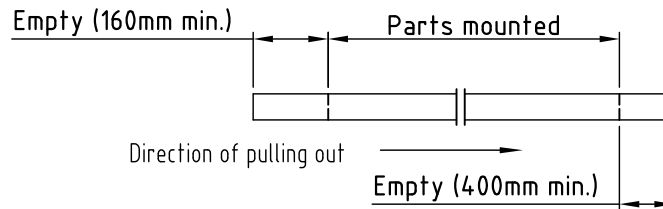

Drawing refers to following types: VLMU3511...
Reel dimensions and tape

Drawing-No.: 9.800-5139.01-4
Issue: prel; 02.03.16

MOQ: 1000 pieces (2 reels each with 500 pieces)

HANDLING RECOMMENDATIONS

In order to achieve excellent lifetime, the package of these UV-LEDs consists of a ceramic substrate in combination with a UV stable silicone as lens material. Compared to standard materials silicone is generally softer and it tends more to attract dust:

- Minimize the level of dirt and dust particles in contact with the LED
- Small amounts of particles on the LEDs, although noticeable from a cosmetic point of view, do not affect the performance in terms of brightness, reliability and quality
- If cleaning is required, a short rinsing with isopropyl alcohol, not longer than 15 seconds, is recommended. Do not use ultrasonic cleaning, it may damage the LED
- Do not apply mechanical stress on the silicone lens
- Avoid any piercing of the silicone lens by sharp objects
- It is recommended to use a suitable pick and place tool for the removal of the LED from blister tape without applying stress to the lens. The recess of the pick-up needle has to be larger than the silicone lens
- For manual handling using tweezers make sure that the LED will be touched carefully at the sidewall of the ceramic substrate, but not at the silicone lens

SOLDERING PROFILE

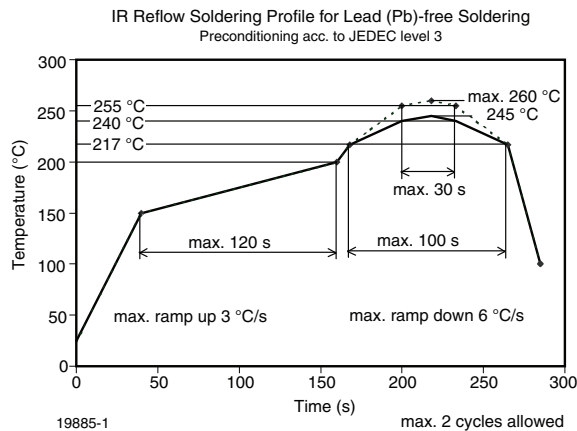
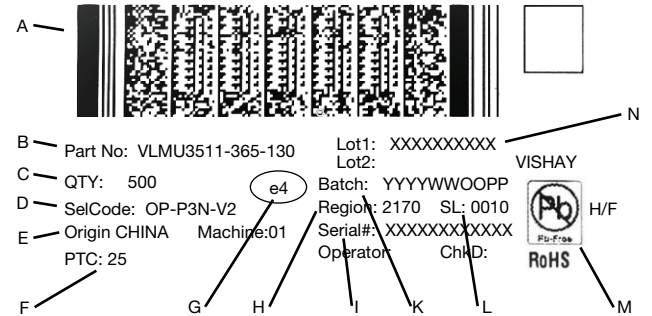

Fig. 8 - Vishay Lead (Pb)-free Reflow Soldering Profile (acc. to J-STD-020C)

BAR CODE PRODUCT LABEL (example only)



- A. 2D barcode
- B. Part No: Vishay part number
- C. QTY: quantity
- D. SelCode: selection bin code
- E. Country of origin
- F. PTC: production plant code
- G. Termination finish
- H. Region code
- I. Serial#: serial number
- K. Batch number: year, week, country code, plant code
- L. SL: sales location
- M. Environmental symbols: RoHS, lead (Pb)-free, halogen free
- N. Lot numbers

DRY PACKING

The reel is packed in an anti-humidity bag to protect the devices from absorbing moisture during transportation and storage.

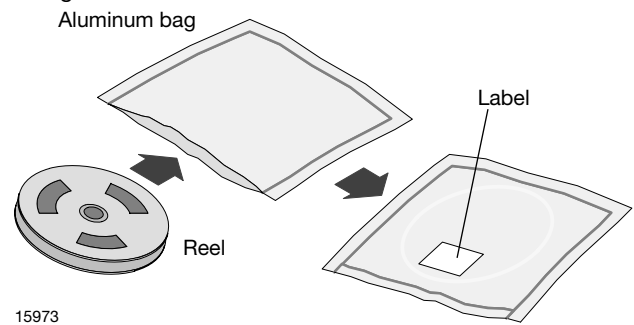

FINAL PACKING

The sealed reel is packed into a cardboard box. A secondary cardboard box is used for shipping purposes.



RECOMMENDED METHOD OF STORAGE

Dry box storage is recommended as soon as the aluminum bag has been opened to prevent moisture absorption. The following conditions should be observed, if dry boxes are not available:

- Storage temperature 10 °C to 30 °C
- Storage humidity ≤ 60 % RH max.

After more than 168 h under these conditions moisture content will be too high for reflow soldering.

In case of moisture absorption, the devices will recover to the former condition by drying under the following condition:

192 h at 40 °C + 5 °C / - 0 °C and < 5 % RH (dry air / nitrogen) or

24 h at 60 °C + 5 °C and < 5 % RH for all device containers or

24 h at 100 °C + 5 °C not suitable for reel or tubes.

An EIA JEDEC® standard JESD22-A112 level 3 label is included on all dry bags.

ESD PRECAUTION

Proper storage and handling procedures should be followed to prevent ESD damage to the devices especially when they are removed from the antistatic shielding bag. Electrostatic sensitive devices warning labels are on the packaging.

VISHAY SEMICONDUCTORS STANDARD BAR CODE LABELS

The Vishay Semiconductors standard bar code labels are printed at final packing areas. The labels are on each packing unit and contain Vishay Semiconductors specific data.

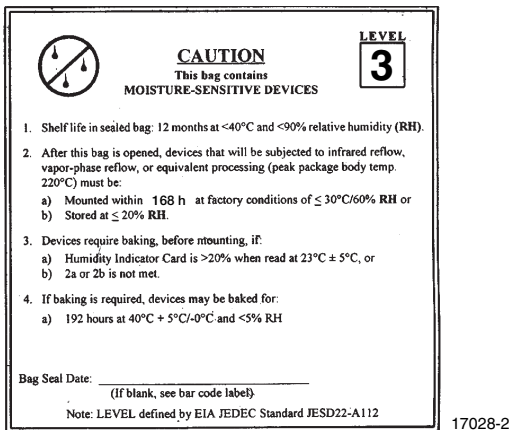

Example of JESD22-A112 level 3 label



Disclaimer

ALL PRODUCT, PRODUCT SPECIFICATIONS AND DATA ARE SUBJECT TO CHANGE WITHOUT NOTICE TO IMPROVE RELIABILITY, FUNCTION OR DESIGN OR OTHERWISE.

Vishay Intertechnology, Inc., its affiliates, agents, and employees, and all persons acting on its or their behalf (collectively, "Vishay"), disclaim any and all liability for any errors, inaccuracies or incompleteness contained in any datasheet or in any other disclosure relating to any product.

Vishay makes no warranty, representation or guarantee regarding the suitability of the products for any particular purpose or the continuing production of any product. To the maximum extent permitted by applicable law, Vishay disclaims (i) any and all liability arising out of the application or use of any product, (ii) any and all liability, including without limitation special, consequential or incidental damages, and (iii) any and all implied warranties, including warranties of fitness for particular purpose, non-infringement and merchantability.

Statements regarding the suitability of products for certain types of applications are based on Vishay's knowledge of typical requirements that are often placed on Vishay products in generic applications. Such statements are not binding statements about the suitability of products for a particular application. It is the customer's responsibility to validate that a particular product with the properties described in the product specification is suitable for use in a particular application. Parameters provided in datasheets and / or specifications may vary in different applications and performance may vary over time. All operating parameters, including typical parameters, must be validated for each customer application by the customer's technical experts. Product specifications do not expand or otherwise modify Vishay's terms and conditions of purchase, including but not limited to the warranty expressed therein.

Hyperlinks included in this datasheet may direct users to third-party websites. These links are provided as a convenience and for informational purposes only. Inclusion of these hyperlinks does not constitute an endorsement or an approval by Vishay of any of the products, services or opinions of the corporation, organization or individual associated with the third-party website. Vishay disclaims any and all liability and bears no responsibility for the accuracy, legality or content of the third-party website or for that of subsequent links.

Except as expressly indicated in writing, Vishay products are not designed for use in medical, life-saving, or life-sustaining applications or for any other application in which the failure of the Vishay product could result in personal injury or death. Customers using or selling Vishay products not expressly indicated for use in such applications do so at their own risk. Please contact authorized Vishay personnel to obtain written terms and conditions regarding products designed for such applications.

No license, express or implied, by estoppel or otherwise, to any intellectual property rights is granted by this document or by any conduct of Vishay. Product names and markings noted herein may be trademarks of their respective owners.